

电路简图
(带点通功能)
SCHEMATIC (NON-SHORTING)

注：“*”□表示关键尺寸(3个)。

NO.	PARTS	MATERIALS	Q'TY		TOLERANCE UNLESS SPECIFIED					
8										
7										
6					WITHIN 1.5mm : ±0.1mm	A	2012-8-13	初版		
5	SPRING	SUS	1	NATURAL	OVER 1.5mm : ±0.2mm	ISSUE	DATE	DESCRIPTIONS OF REVISION	APPD.	
4	CAM STICK	SUS	1	NATURAL	TITLE : VERTICAL PUSH SWITCH				UNIT : mm	DRWG NO.:
3	CASE	PA66/BRASS STRIP	1	GREY/Ag PLATED	MODEL:				SCALE: 5:1	
2	COVER	PA66	1	BLACK	东莞市高迪电子有限公司				DWN.	2012-8-13
1	KNOB	PA66/PBS C5210R-EH	1	WHITE/Ag CLAD					CHK'D	
								APPD.		

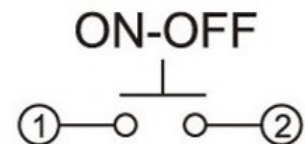
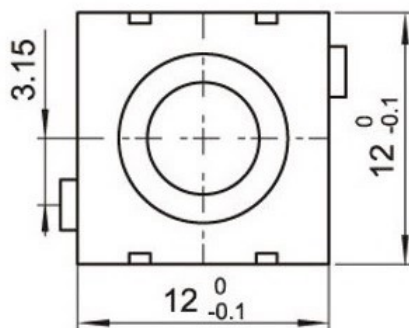
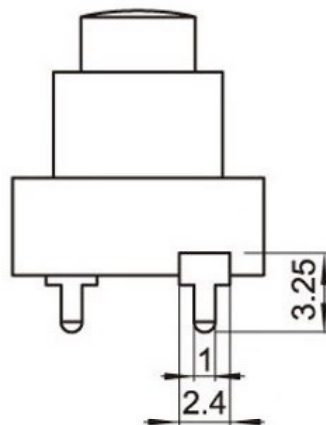
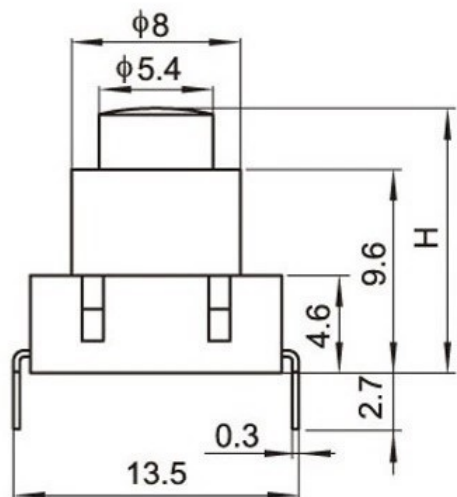
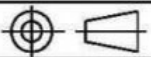

电路简图
(带点通功能)

SCHEMATIC (NON-SHORTING)

注：“*”□表示关键尺寸(3个)。

NO.	PARTS	MATERIALS	Q'TY		TOLERANCE UNLESS SPECIFIED				
8									
7									
6					WITHIN 1.5mm : ±0.1mm	A	2012-8-13	初版	
5	SPRING	SUS	1	NATURAL	OVER 1.5mm : ±0.2mm	ISSUE	DATE	DESCRIPTIONS OF REVISION	APPD.
4	CAM STICK	SUS	1	NATURAL	TITLE : VERTICAL PUSH SWITCH			UNIT : mm	DRWG NO.:
3	CASE	PA66/BRASS STRIP	1	GREY/Ag PLATED	MODEL:			SCALE: 5:1	DWN.
2	COVER	PA66	1	BLACK	东莞市高迪电子有限公司				2012-8-13
1	KNOB	PA66/PBS C5210R-EH	1	WHITE/Ag CLAD				CHK'D	
								APPD.	

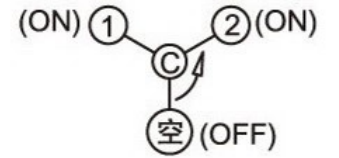
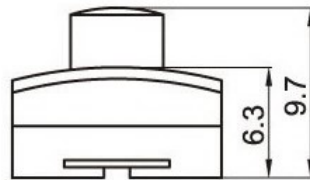
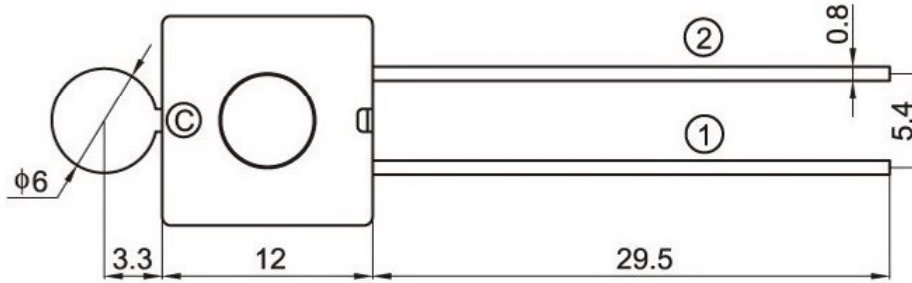
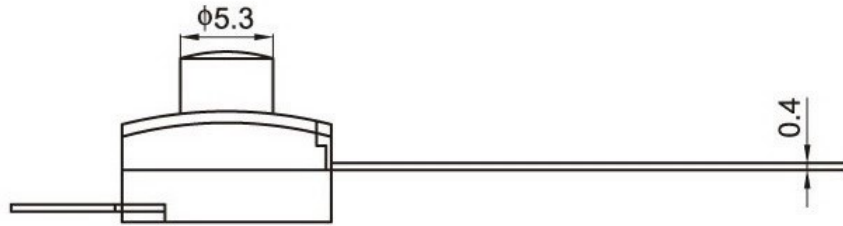
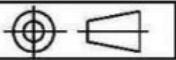

ON-ON-OFF
SCHEMATIC (NON-SHORTING)

注：“*”□表示关键尺寸(3个).

NO.	PARTS	MATERIALS	Q'TY		TOLERANCE UNLESS SPECIFIED				
8									
7									
6					WITHIN 1.5mm : ±0.1mm	A	2012-8-13	初版	
5	SPRING	SUS	1	NATURAL	OVER 1.5mm : ±0.2mm	ISSUE	DATE	DESCRIPTIONS OF REVISION	APPD.
4	CAM STICK	SUS	1	NATURAL	TITLE : VERTICAL PUSH SWITCH			UNIT : mm	DRWG NO.:
3	CASE	PA66/BRASS STRIP	1	GREY/Ag PLATED	MODEL:			SCALE: 5:1	DWN.
2	COVER	PA66	1	BLACK	东莞市高迪电子有限公司				2012-8-13
1	KNOB	PA66/PBS C5210R-EH	1	WHITE/Ag CLAD				CHK'D	
								APPD.	